

EsCape

Whatever it Takes

Harrjeeth Senthil Kumar
3rd Sem – Design Studio, LPU
2018



There is a pleasure in the pathless woods;
There is a rapture on the lonely shore;
There is society, where none intrudes,
By the deep sea, and music in its roar:
I love not man the less, but Nature more...

- Lord Byron

Initial Interpretation

I concluded with a design of a
Simple outfit to a
Simple tent and a
Simple hammock
All in a single product.

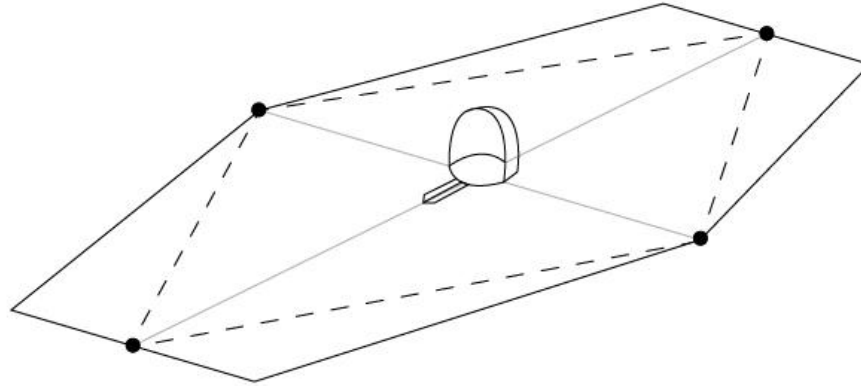

A stretched out view of a
poncho raincoat

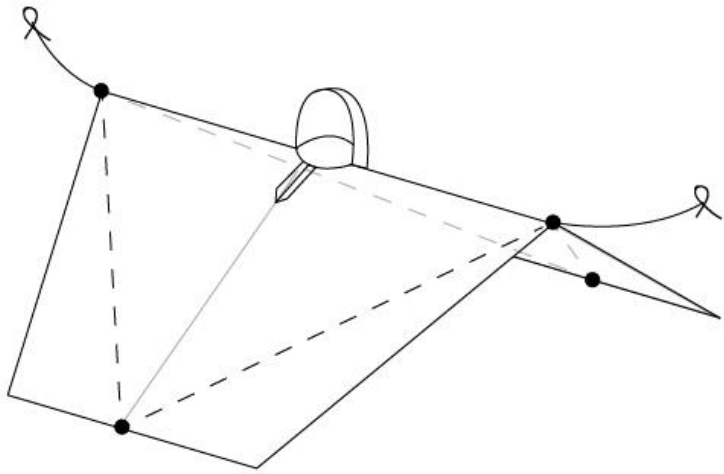

A simple tent when the two
smaller sides are grounded.

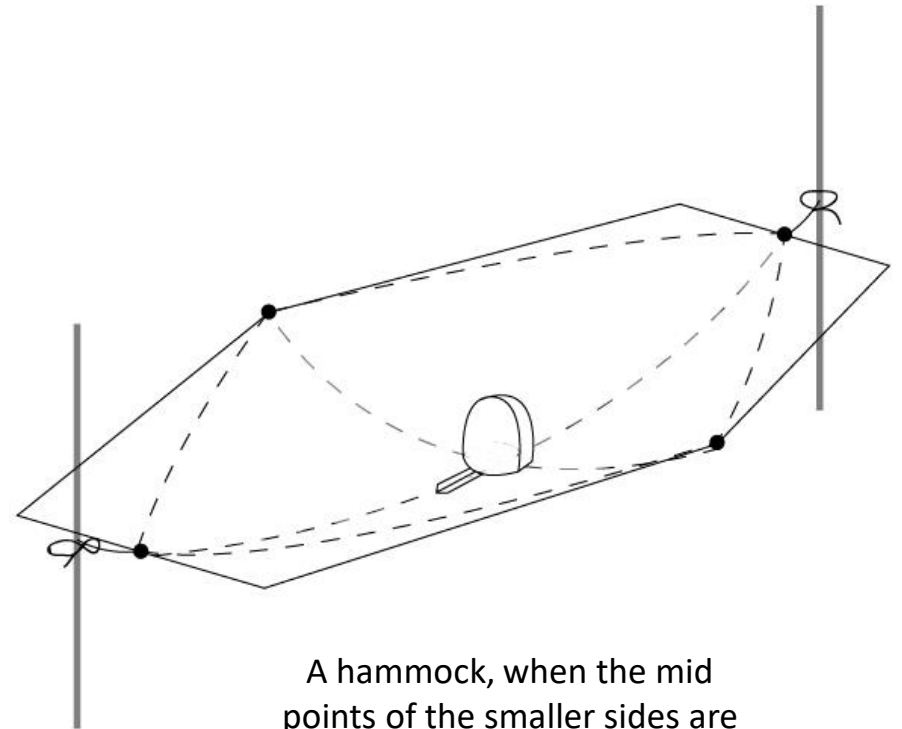

A hammock, when the mid
points of the smaller sides are
tied to poles.

(All illustrations in perspective view)

Subjective Survey

The following are my observations from my survey of 65 subjects.

1. Gender

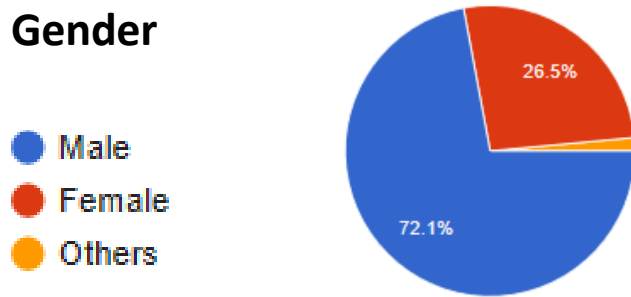

2. Height

No. of subjects

Less than 5 feet	7
5 feet	11
Less than 6	32
6 and above	15

3. Do you prefer to use a raincoat?

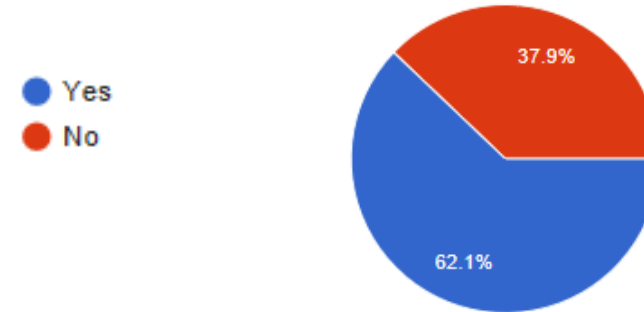

4. How often do you travel?

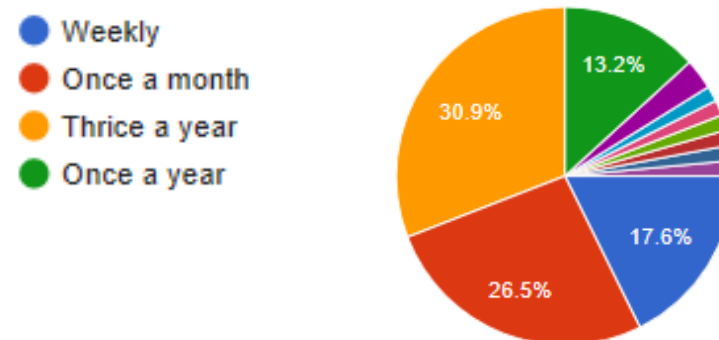

5. Number of people you wish to travel with?

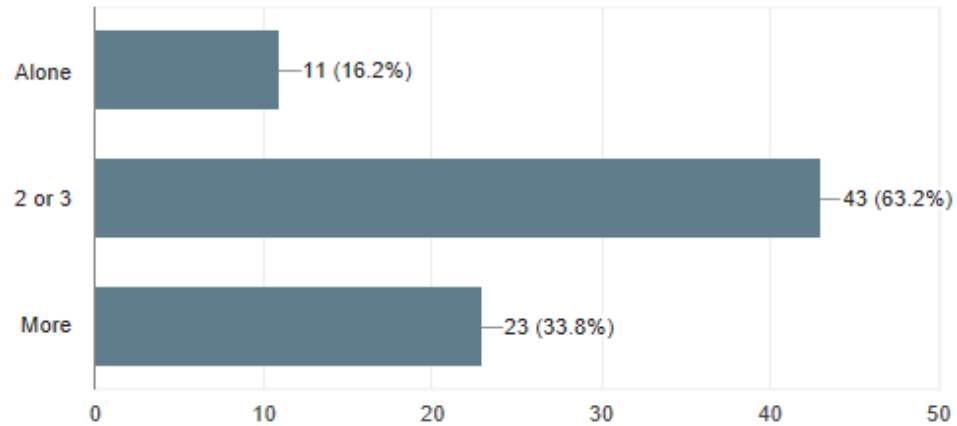

6. Travel preference?

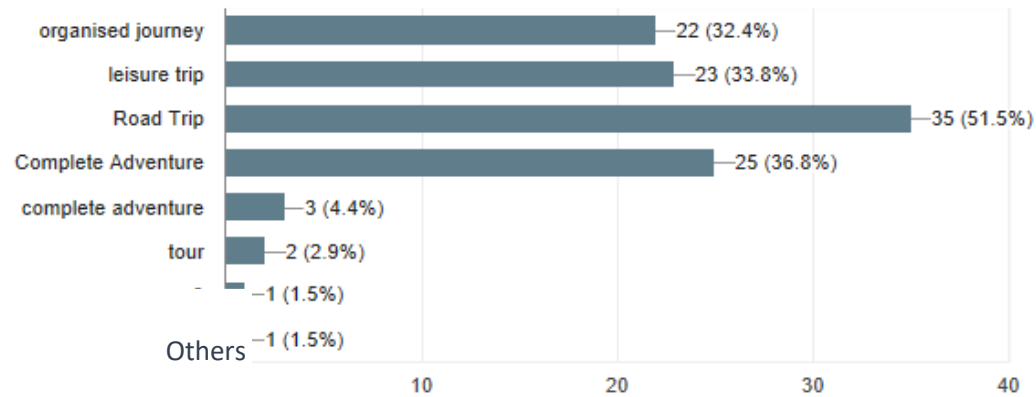

7. Prefer to stay in tents?

● Yes
● No

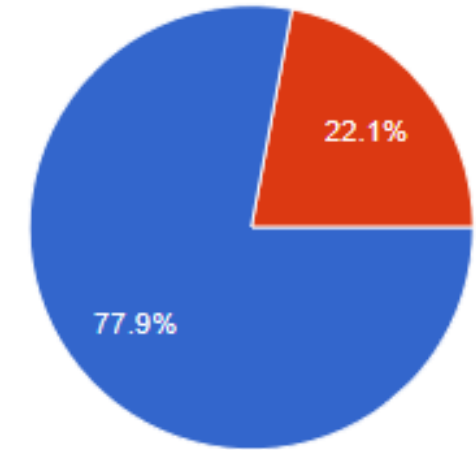

8. Prefer to rest in hammock?

● Yes
● No

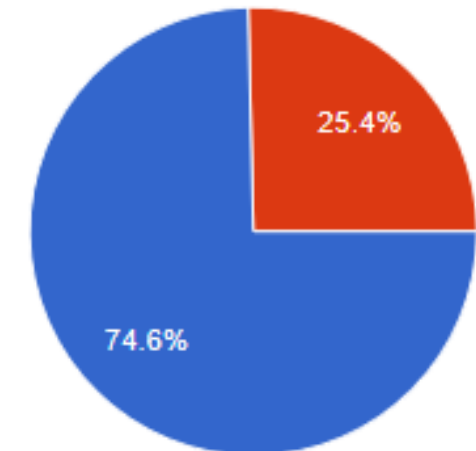

User Journey from movie "Into the Woods"



User need, dangers and adaptations



Clothing Shelter Food

- **A *Durable Luck***- This product has to give one hope for safe health during his survival trip. And such a hope should last till the end of his life and still last.
- **Adhesion resistance**- The material has to be a super powered skin that is tough to wear off. Well even if one could get a scratch mark or any damage over it, it will be the memory of his badass experience.
- **Adjustable air-vents**- This all terrain outfit has to keep one completely insulated at peaks of Himalayas and also keep him cool in the middle of Thar desert.
- **Waterproof**
- **Breathable**
- **Comfortable**
- **Rugged look**

Brainstorming

Adaptable in all Terrain

Face Cover

Insects Protection

Storage Areas

Freedom

Easy to Use

Optimised Space

Adaptable to Body Movements

Waterproof

Ready for Thunder

Boost Confidence

Luck

Reversible Wear

Badass Experience

Secure

Safety First

Fit

Breathable

Hope

Shield

Durable

Rugged

Adhesion resistance

Comfortable

User Friendly

Tough

4 Way Stretch

Convertible to Multiutility

Less Weight

Easy Portability

Compact

Protector

Fast Drying

New

Adjustable Air-Vents

Bacterial Resistant

Forever

Mood Board



Ideations



Software used-
Marvelous Designer

As the entire design was turning to be like **fashion designing**, I had to change my **approach**.

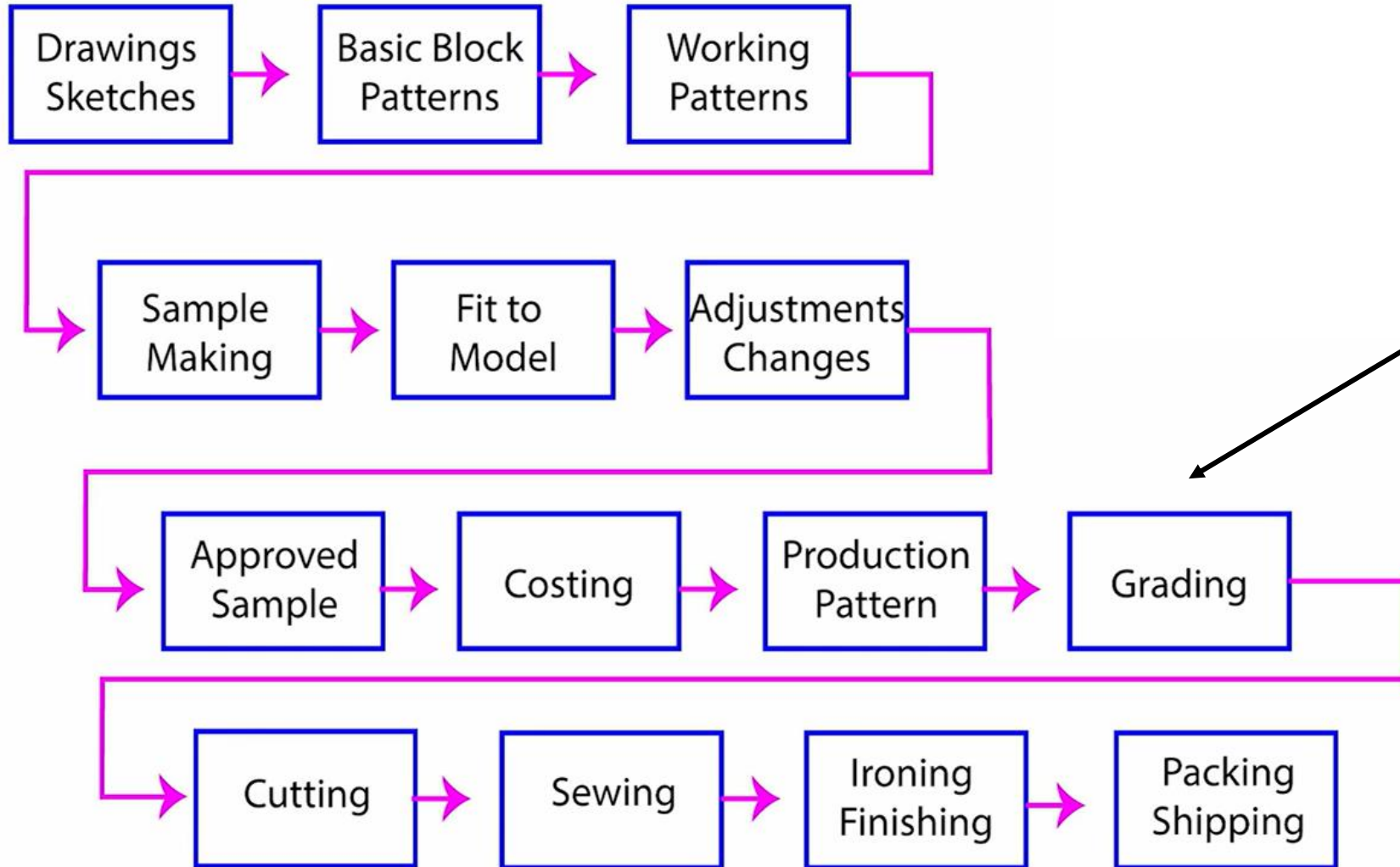

This is the step where I provide **dimensions** for different size for people.

Final Design



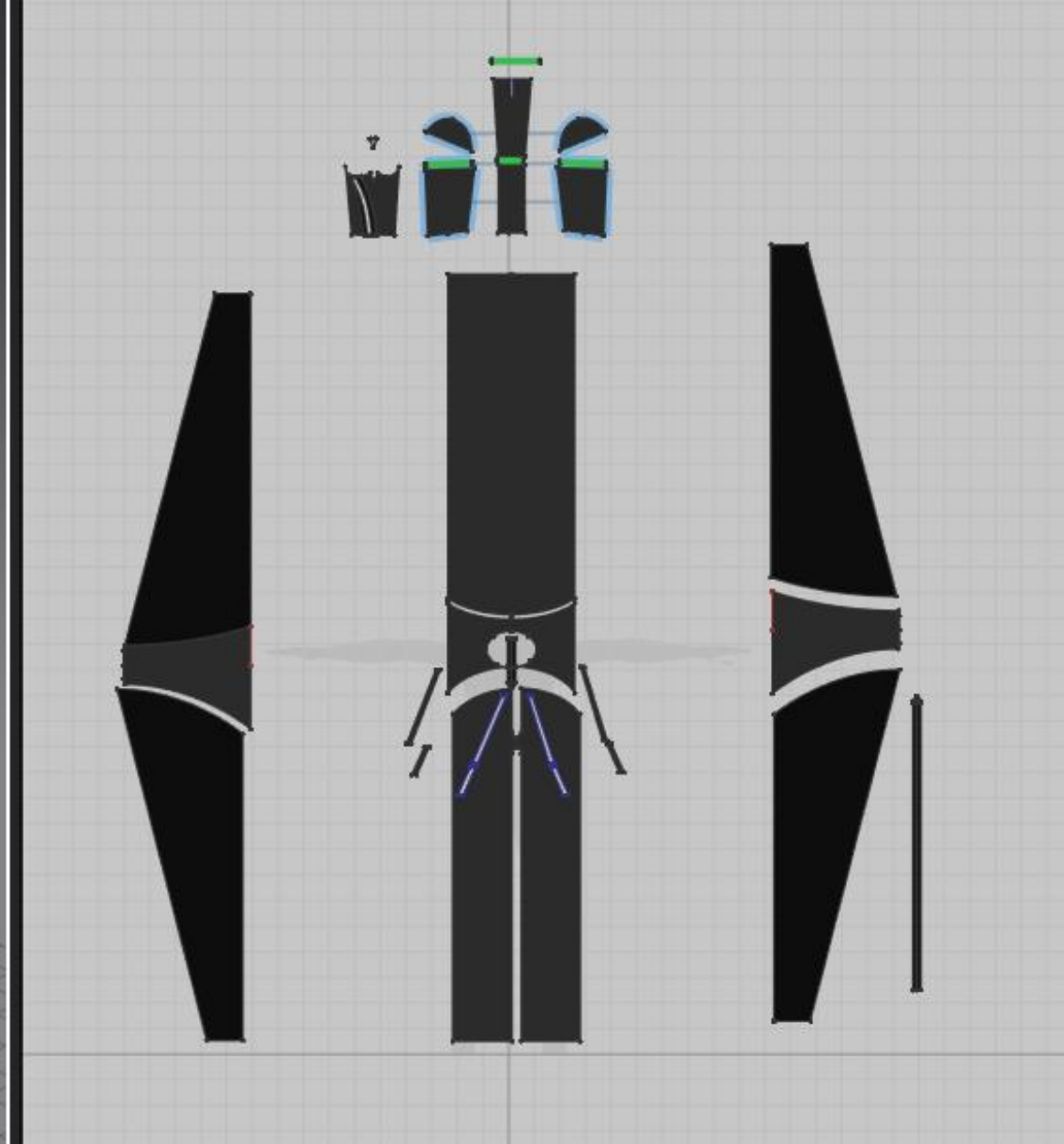

Pattern with dimension ready software simulation in
Marvellous Designer





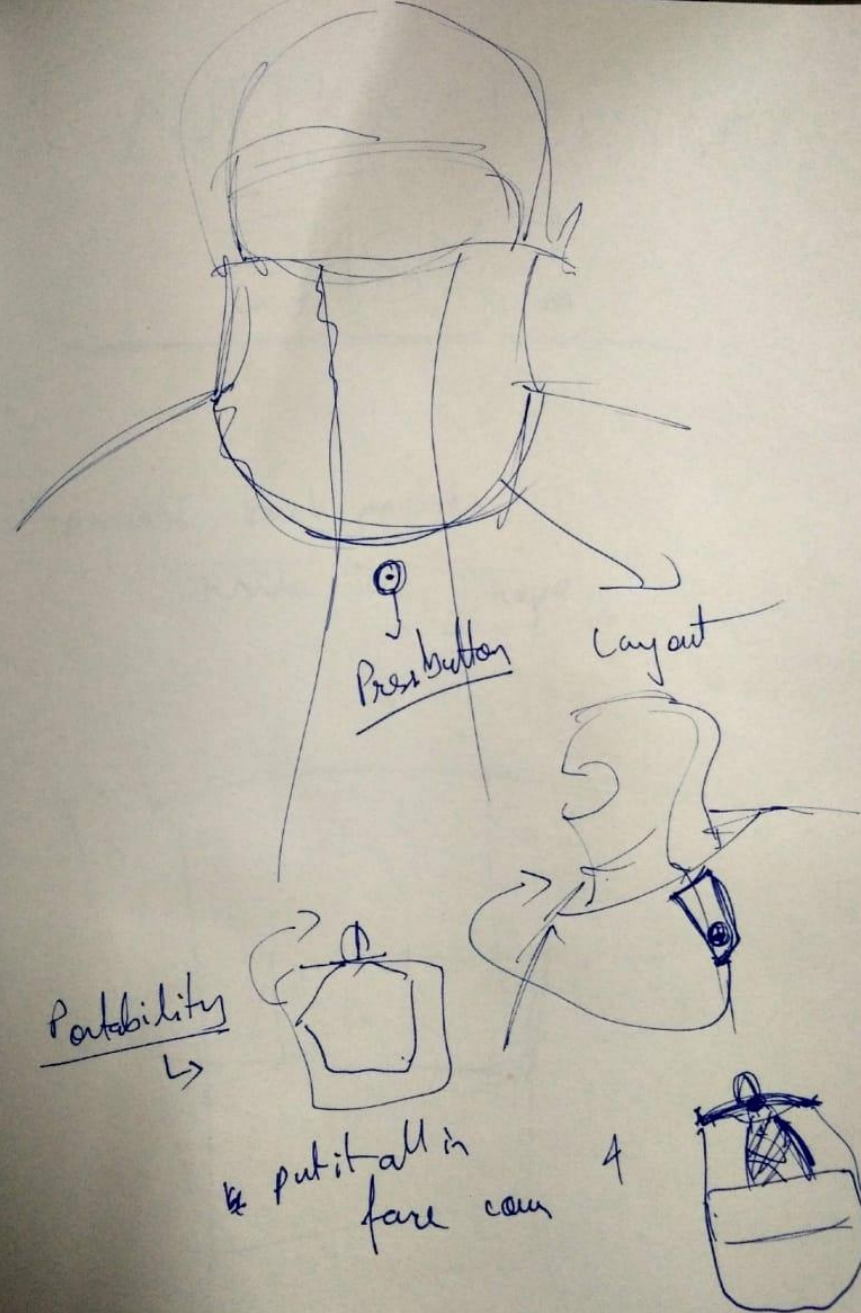
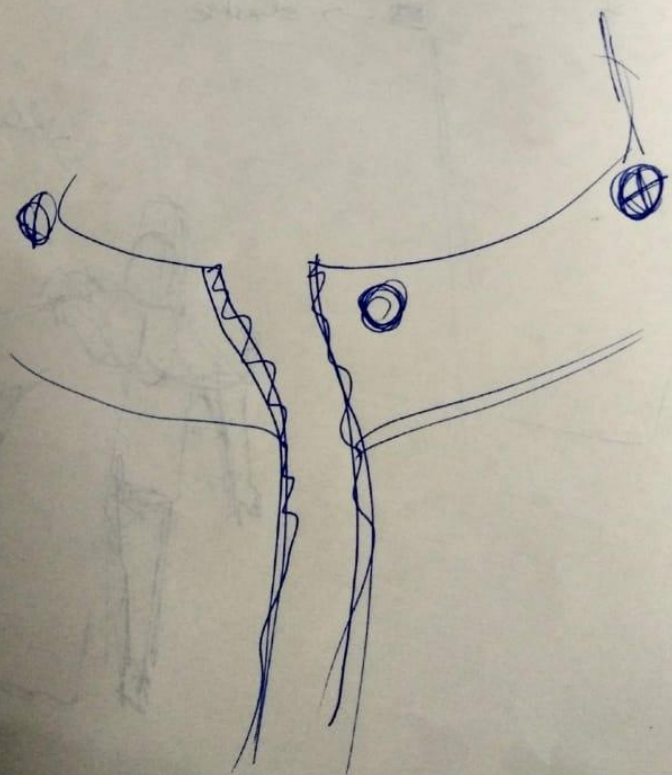
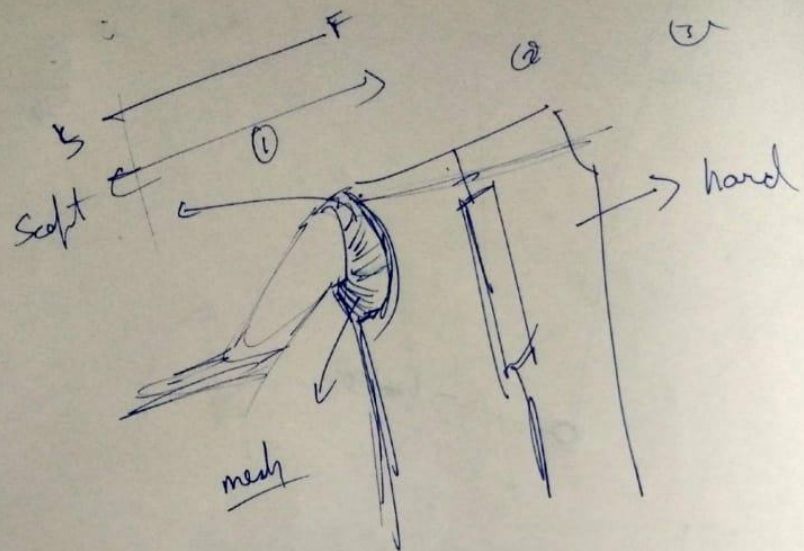

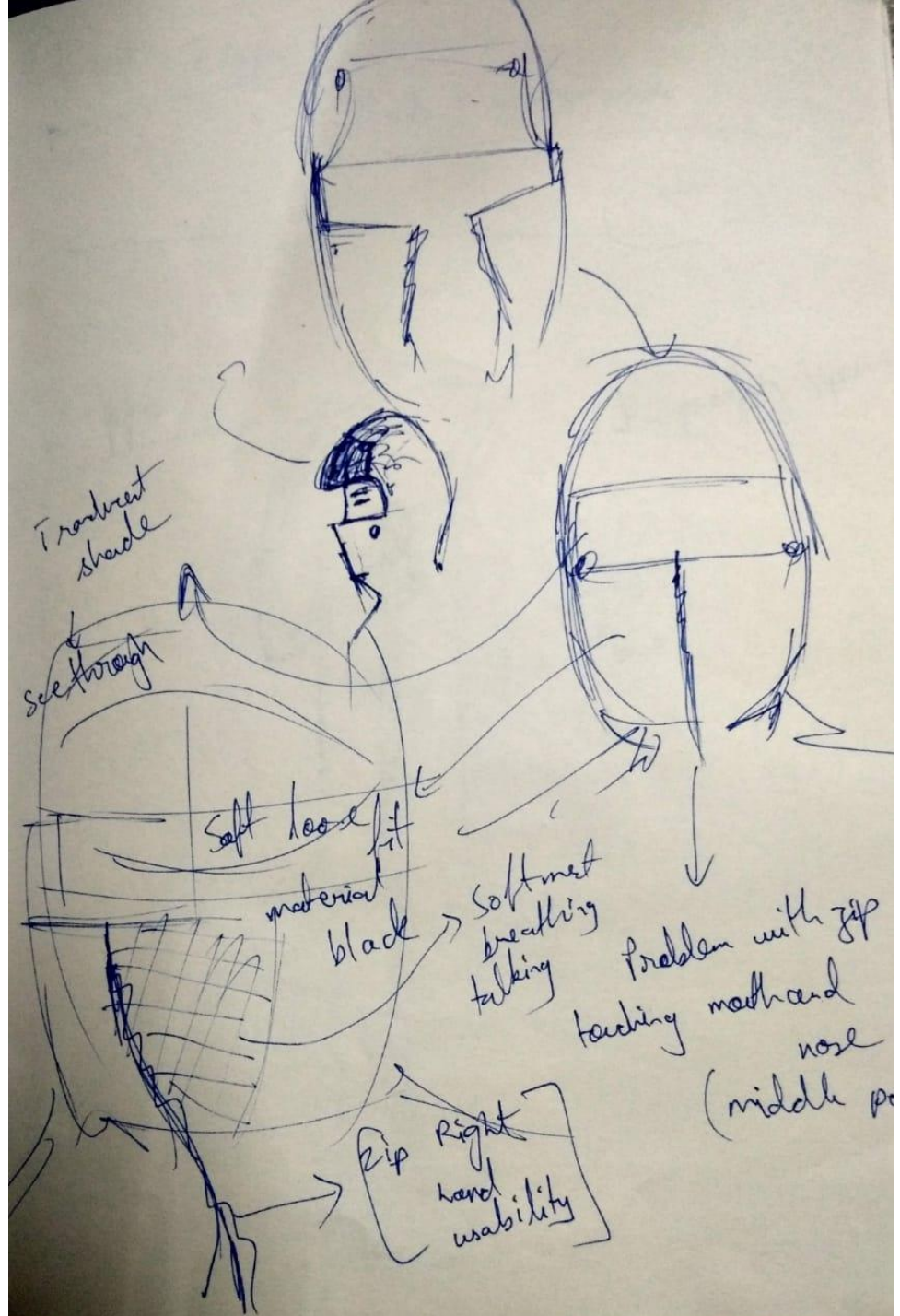

ENTIRE DESIGN
EASY!

Special back pockets
inside the Drape

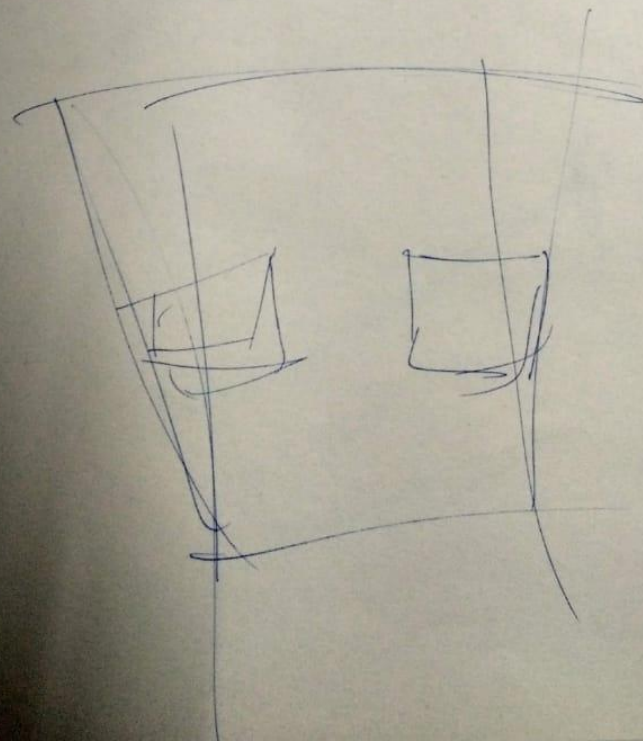

FRONT POCKETS

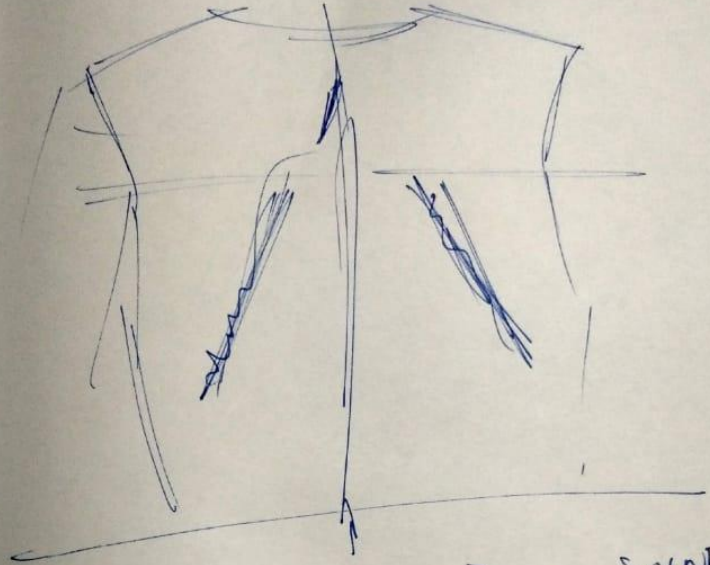

BACK SPINE VIEW

MESH

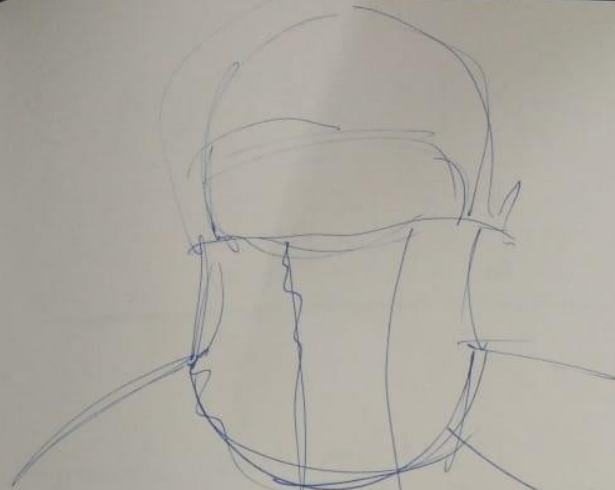
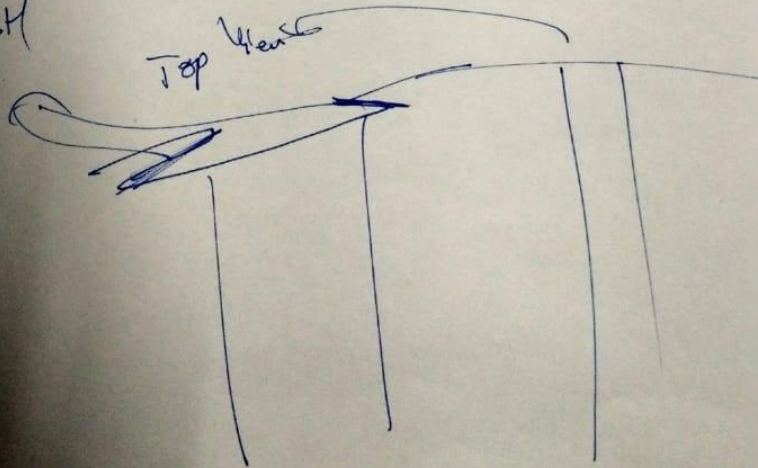

Press button

Lay out



Portability



put it all in face cam



Standing Height
Sitting Height



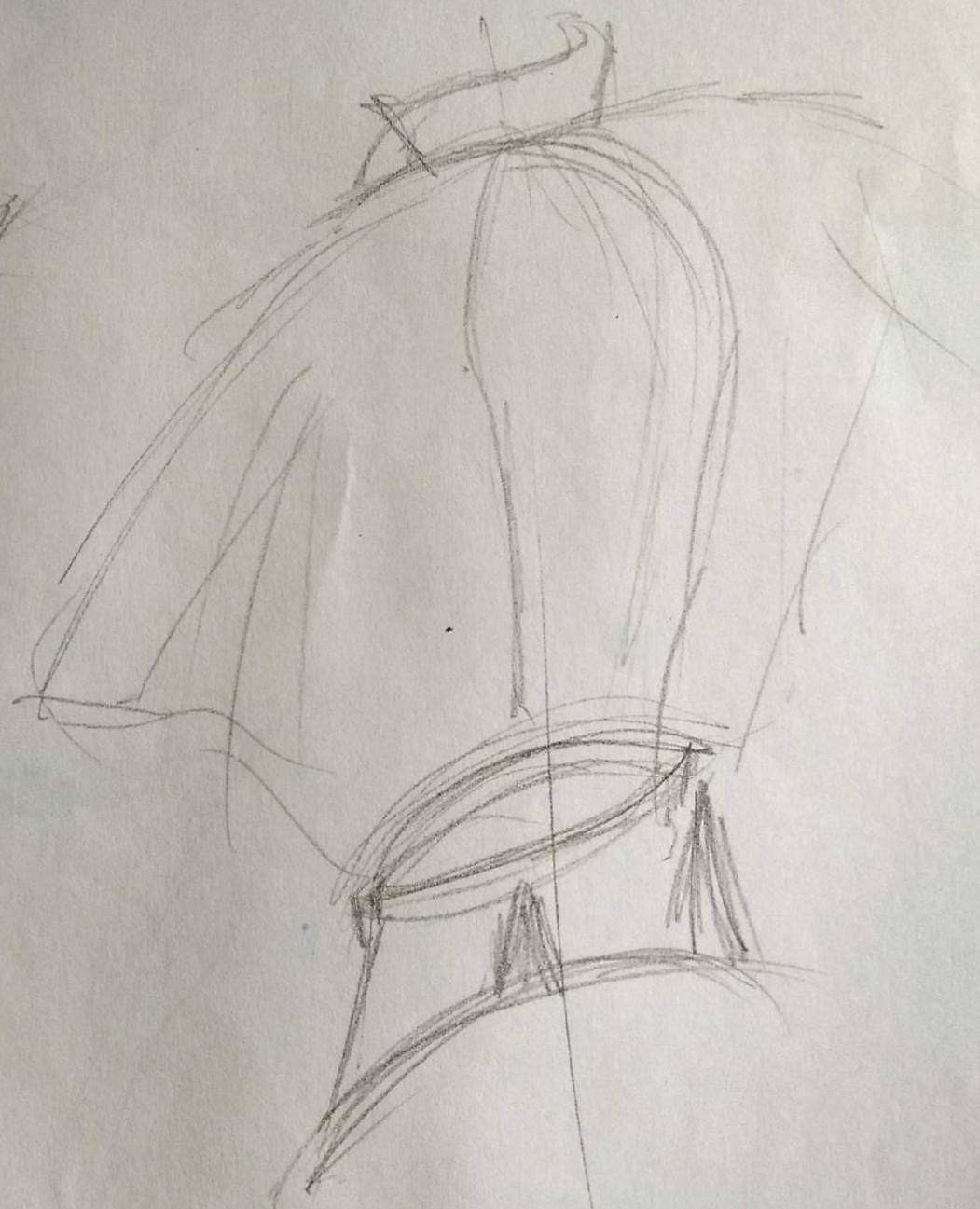

THE MUST FACTORS

- HEAD COVER - COVERING FACE
- PROTECTS ENTIRE BODY
- ADAPTABLE TO BODY POSTURES / MOVEMENTS
- UNFOLDABLE TO A SIMPLE CLOTH
- COMPACT / COMFORTABLE

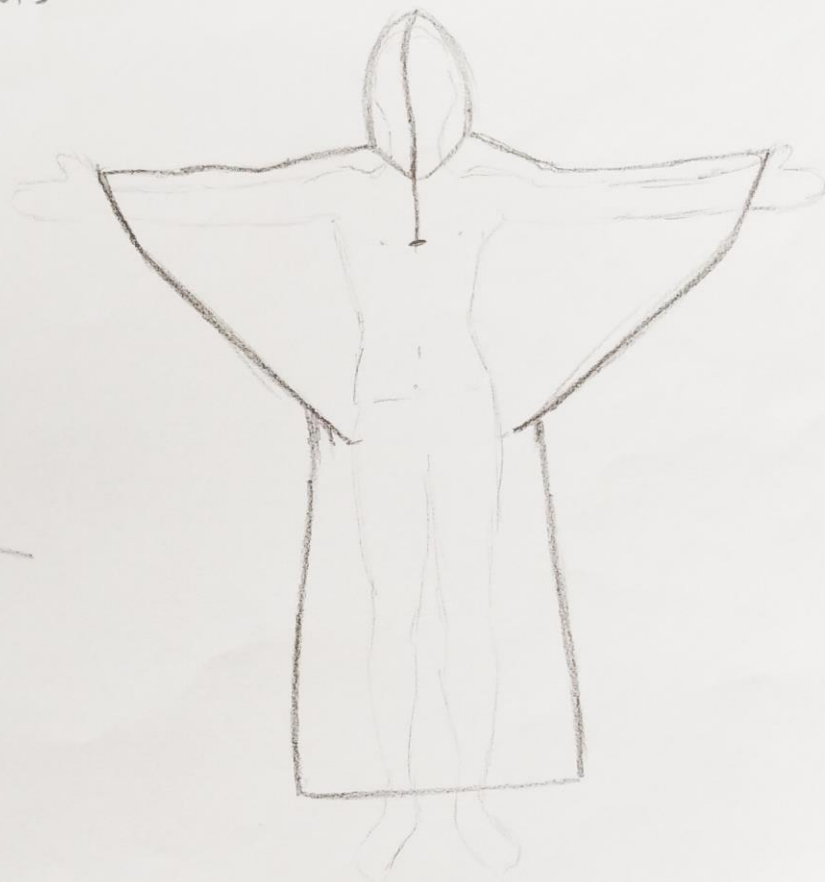
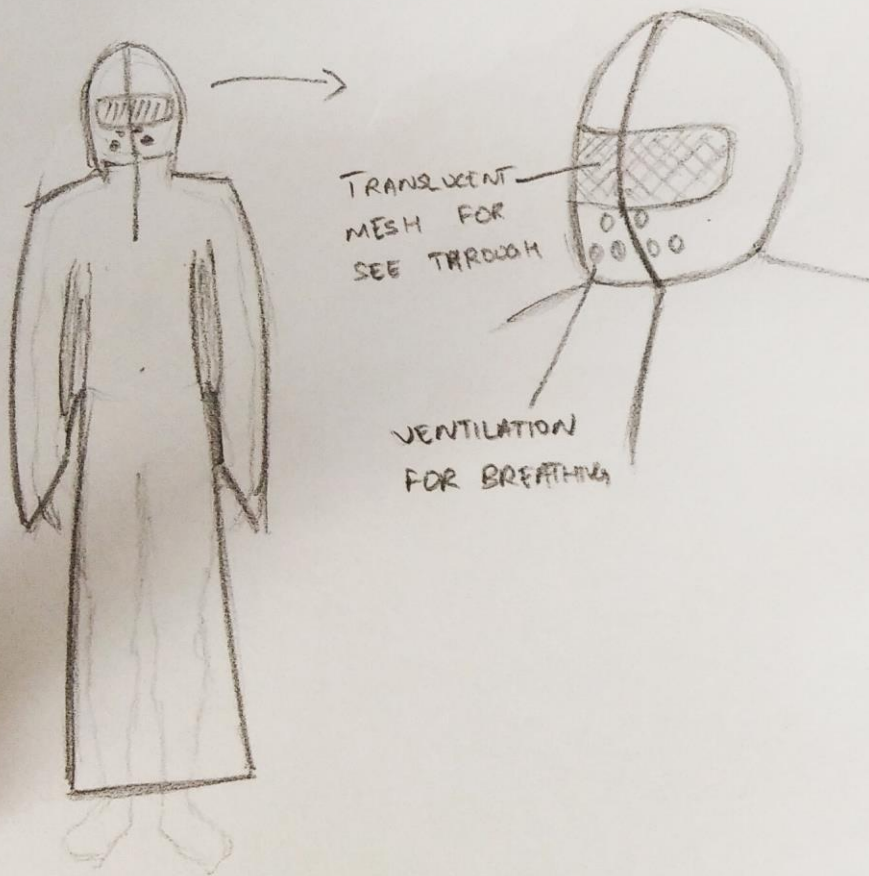

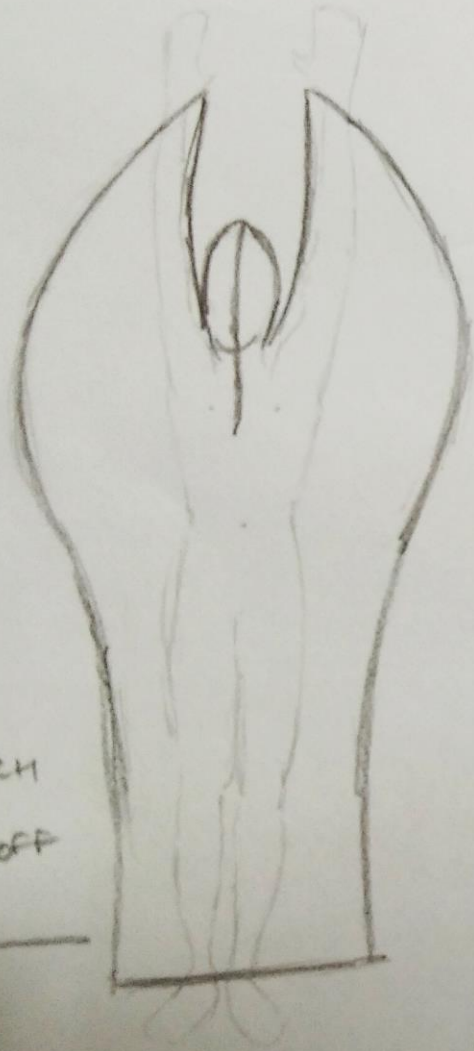

TOO MUCH
WASTE OFF
SPACE

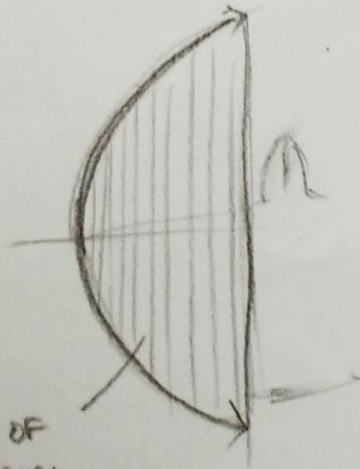
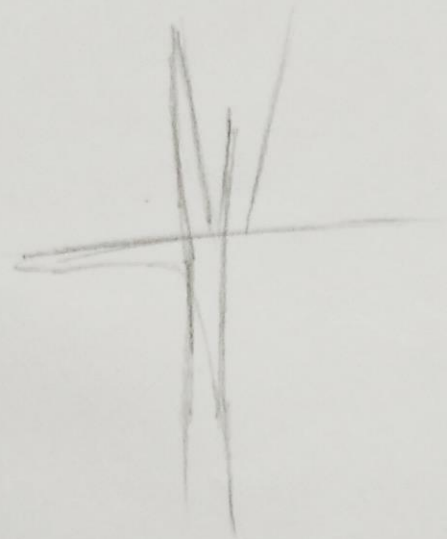

AREA OF
MATERIAL
REQUIRED

HAND MOVEMENT

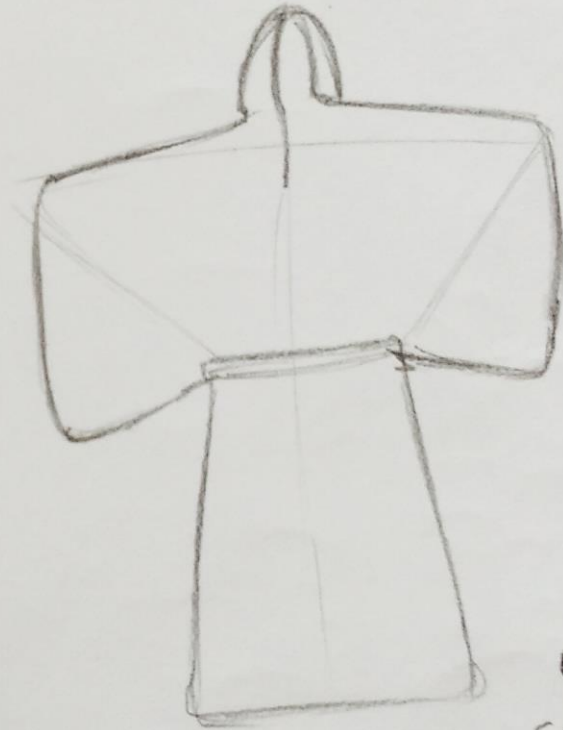

NOT
SUITABLE FOR
TRAVELLING

Translucent/Transparent
mesh
Eye Protected Eye sight

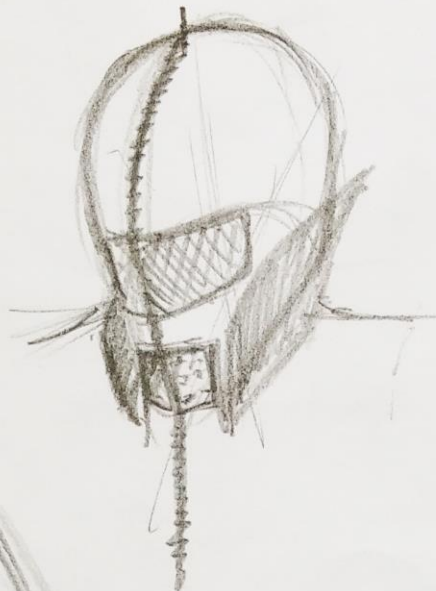

Two way
zip
waterproof

